

# pco.dicam C1

intensified 16 bit **sCMOS** camera

1 channel  
**intensified  
sCMOS**

intensified  
**sCMOS** technology  
2048 x 2048 pixel

**VUV detection**  
down to 110 nm

**106 fps**  
@ full resolution

**10G fiber optic**  
data interface



**exposure time 4 ns**  
with 25 mm intensifier

**double image mode**  
with 300 ns interframing time



After more than 30 years of experience with image intensified cameras, we are proud to introduce the new pco.dicam C1 to you. The pco.dicam C1 is the first intensified camera system which exploits the full performance inherent to **scientific CMOS** sensor technology.

It is the optical coupling of 25 mm high resolution image intensifiers with an outstanding high efficiency tandem lens system to a 16 bit 4 MPixel **sCMOS** sensor which makes the camera so unique. The 10G fiber optic based data interface (CLHS FOL) guarantees you uncompressed and robust 16 bit data transfer of 106 full frames per second via optical fiber over virtually any distance.

## features & benefits

<b>106 fps @ full 4.2 MPixel resolution</b>	high frame rates at high resolution for imaging of dynamic processes
<b>&gt; 7000 fps @ reduced resolution</b>	kHz scan rates for spectroscopic applications
<b>1.1 e<sup>-</sup> readout noise</b>	lowest readout noise of any gated intensified camera system
<b>16 bit digitization</b>	taking advantage of the higher dynamic range possible from high-end image intensifiers
<b>25 mm high resolution image intensifier</b>	doubles the optical resolution of conventional 18 mm image intensifiers
<b>optical coupling via ultra-speed tandem lens</b>	outstanding image quality with high transmission efficiency and no artifacts
<b>tandem lens with 0.53 : 1 image scaling</b>	full 25 mm diameter of intensifier output is imaged (lossless) onto an sCMOS sensor
<b>10G fiber optic based data interface</b>	fiber optic interface virtually covers any distance without deploying additional interface converters or signal amplifiers with immunity to EMI
<b>880 MByte/s image data rate</b>	highest sustained image data rate of any intensified camera system on the market; no limitations for recording duration
<b>double image mode with 300 ns interframing time</b>	two consecutive full resolution images with a configurable minimum interframing time of 300 ns
<b>4.2 MPixel sCMOS sensor</b>	overcomes CCD limitations in terms of speed and sensitivity
<b>enhanced extinction ratio gating</b>	fast MCP gating for improved extinction ratio for the blue and uv part of the spectrum
<b>additional optical trigger input</b>	robust trigger transmission over long distance in EMC critical environments
<b>lens remote controller (optional)</b>	convenient remote lens control for camera systems inaccessible during an experiment
<b>selected highly homogeneous image intensifiers</b>	integrated best image intensifier quality available on the market
<b>&lt; 50 ns trigger to exposure start delay</b>	ultra fast camera reaction to trigger event
<b>4 ns gating with 25 mm intensifier</b>	captures fast transient phenomena
<b>external modulation of the photocathode sensitivity</b>	multiple exposure with up to 3.3 MHz
<b>VUV detection down to 110 nm with S20 photocathode and MgF<sub>2</sub> input window</b>	sealed camera front mounts to vacuum devices
<b>extensive and highly precise IN/OUT signaling</b>	allows for perfect synchronization in any experimental setup as timing master or slave
<b>configurable delay in steps of 1 ns</b>	flexible adaptation to synchronization needs

## camera components overview

- 1 image intensifier
- 2 optical coupling lens system
- 3 sCMOS image sensor
- 4 camera system
- 5 10G fiber optic based interface

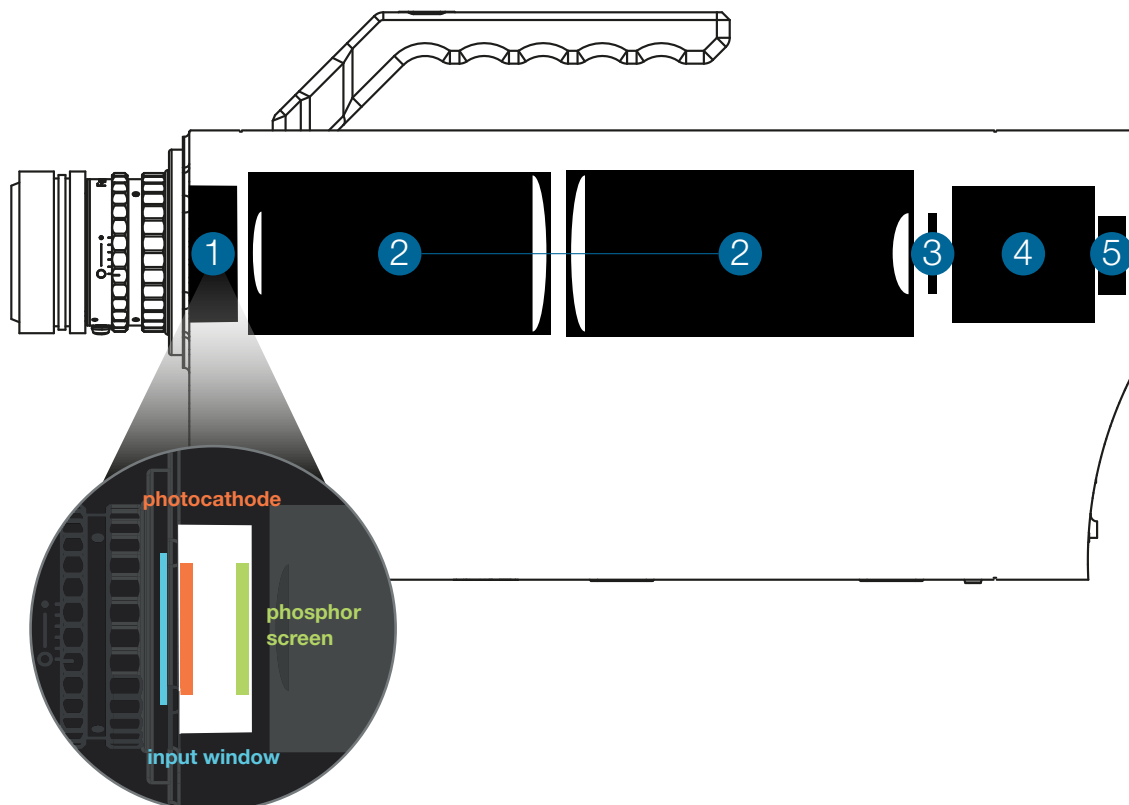

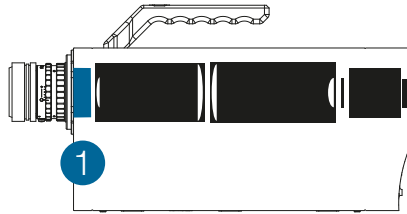

**technical specifications**

» **image intensifier**

<b>type</b>	HighRes micro channel plate (MCP) 6 µm channel
<b>input window</b>	synthetic silica, borosilicate, MgF <sub>2</sub>
<b>photocathode material</b>	S20, GaAs, GaAsP (others on request)
<b>image intensifier pitch distance</b>	6 µm
<b>image intensifier MCP type</b>	single stage low resistance MCP for high strip current
<b>MCP operational modes</b>	continuous gated for enhanced extinction ratio
<b>image intensifier diameter</b>	25 mm (18 mm optional on request)
<b>phosphor screen material</b>	P43, P46
<b>output window</b>	glass
<b>image intensifier system resolution</b>	> 50 lp/mm @ 5 % MTF typical (depends on phosphor)
<b>shortest gating time</b>	4 ns

» **image intensifier input window**

Typical transmittance of image intensifier input window materials.

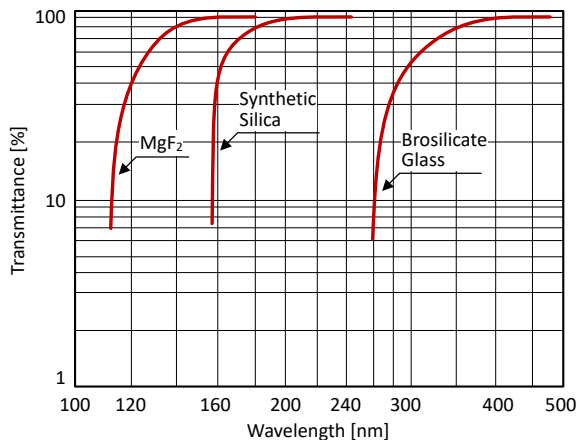

data courtesy of Hamamatsu Photonics

To make use of the good UV sensitivity of S20 photocathode material, the standard input window is made of synthetic silica for transmission down to 180 nm. For VUV detection down to 110 nm, MgF<sub>2</sub> has to be selected as input window.

GaAs and GaAsP photocathodes are deposited on borosilicate glass.

» photocathode quantum efficiency

Spectral sensitivities of different photocathode materials: S20 (multialkali), GaAs, GaAsP

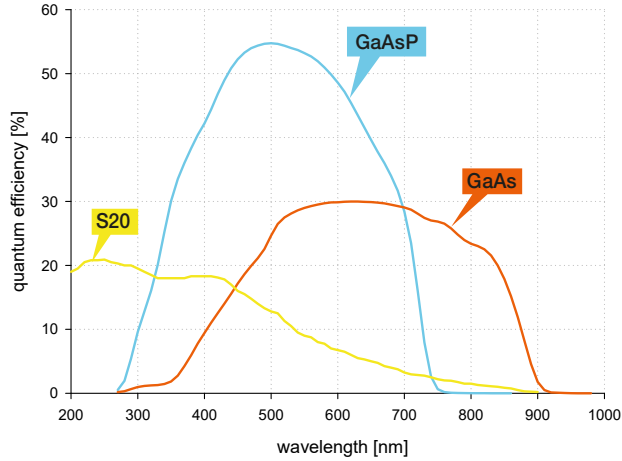

data courtesy of Hamamatsu Photonics

photocathode material	peak wavelength [nm]	typical quantum efficiency at peak wavelength [%]	dark counts [s <sup>-1</sup> /cm <sup>2</sup> ]
S20 (multialkali)	250	20	1500
GaAs	650	30	30,000
GaAsP	500	55	10,000

data courtesy of Hamamatsu Photonics

» image intensifier phosphor

phosphor	phosphor decay (typ.) to..		peak emission	typical efficiency
	.. 10 %	.. 1 %		
P43	1 ms	4 ms	545 nm	100 %
P46	0.2 - 0.4 μs	2 μs	530 nm	30 %

You can combine all photocathode materials with P43 or P46 phosphor. Whereas the P43 phosphor has a much brighter emission than the P46 phosphor, it has a rather long decay time, i.e. the time required until the phosphor emission fades out after the excitation by electron bombardement has been stopped. This decay time is therefore critical for fast image repetition rates, primarily in double image application or when operating the camera in spectroscopic mode with line rates in the kHz range.

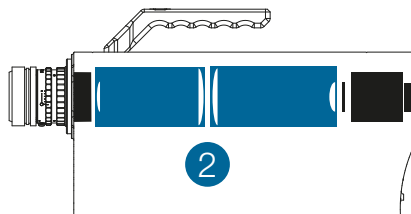

**technical specifications**

» **optical coupling lens system**

“ultra-speed tandem lens” between image intensifier & sCMOS

<b>transmission efficiency</b>	> 30 %
<b>vignetting</b>	< 3 %
<b>resolution</b>	> 60 lp/mm
<b>scaling rates</b>	$\beta=0.53$ for 25 mm intensifier

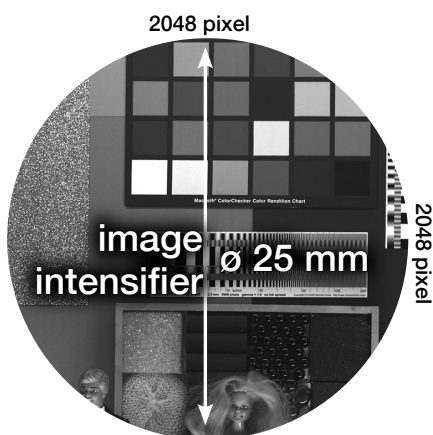

The projected image circle is completely covered by 2048 x 2048 6.5  $\mu\text{m}$  pixels of the sCMOS detector. There is no “waste” of valuable intensifier area. As a consequence, the four corners of the sCMOS sensor remain black. For a fast scan of just a few vertically centered lines – the camera module allows you to achieve more than 7000 fps for such a ROI - the full line length of 2048 pixels is available.

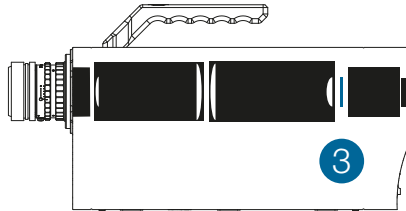

**technical specifications**

» sCMOS image sensor

<b>type of sensor</b>	scientific CMOS (sCMOS)
<b>resolution (h x v)</b>	2048 x 2048 active pixel
<b>pixel size (h x v)</b>	6.5 µm x 6.5 µm
<b>sensor format / diagonal</b>	13.3 mm x 13.3 mm / 18.8 mm
<b>shutter mode</b>	single image double image
<b>MTF<sup>1</sup></b>	76.9 lp/mm (theoretical)
<b>fullwell capacity</b>	15,000 e <sup>-</sup> for P46 phosphor 30,000 e <sup>-</sup> for P43 phosphor
<b>readout noise<sup>2</sup></b>	1.1 med / 1.5 rms e <sup>-</sup> single image 2.2 med / 2.5 rms e <sup>-</sup> double image
<b>dynamic range</b>	13,600 : 1 (82.7 dB) for P46 phosphor 27,200 : 1 (88.7 dB) for P43 phosphor
<b>quantum efficiency</b>	58 % for P43 peak emission @ 545 nm 57 % for P46 peak emission @ 530 nm
<b>spectral range</b>	300 nm ... 1000 nm
<b>dark current<sup>3</sup></b>	< 0.6 e <sup>-</sup> /pixel/s @ 7 °C
<b>DSNU</b>	1.0 rms e <sup>-</sup>
<b>PRNU</b>	< 0.6 %
<b>anti blooming factor</b>	1 : 10,000

» frame rate table<sup>4</sup>

	<b>C1</b>	<b>C4</b>	<b>C8</b>
2048 x 2048	106 fps	424 fps	848 fps
2048 x 1024	210 fps	840 fps	1680 fps
2048 x 512	414 fps	1656 fps	3312 fps
2048 x 256	807 fps	3228 fps	6456 fps
2048 x 128	1535 fps	6140 fps	12,280 fps
2048 x 64	2795 fps	11,180 fps	22,360 fps
2048 x 32	4739 fps	18,956 fps	37,912 fps
2048 x 16	7266 fps	29,064 fps	58,128 fps
1920 x 1080	199 fps	796 fps	1592 fps
1600 x 1200	180 fps	720 fps	1440 fps
1280 x 1024	210 fps	840 fps	1680 fps
640 x 480	441 fps	1764 fps	3528 fps
320 x 240	858 fps	3432 fps	6864 fps

<sup>1</sup> Modulation transfer function.

<sup>2</sup> The readout noise values are given as median (med) and root mean square (rms) values due to the different noise models, which can be used for evaluation. All values are raw data without any filtering.

<sup>3</sup> Measurements with dark current compensation.

<sup>4</sup> Exposure time < 1 µs.

» perfect fit: phosphor emission vs. sCMOS quantum efficiency

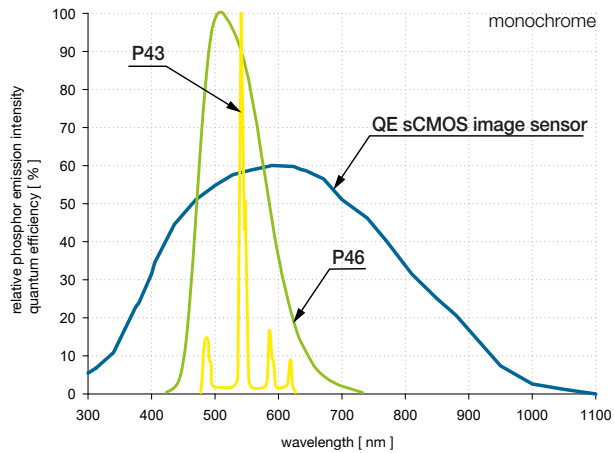

This chart describes the spectral situation for the internal imaging of the image intensifier's phosphor output screen to the sCMOS sensor of the camera detector module. This imaging is done by the highly efficient tandem lens system.

Please note: The spectral sensitivity relevant for your experiment is solely determined by the QE curve of the photocathode material of the image intensifier (page 5).



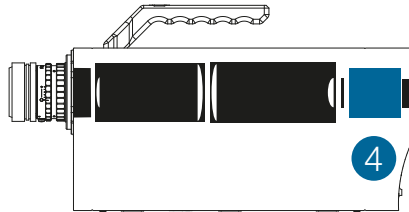

**technical specifications**

» camera system

<b>frame rate</b>	106 fps @ 2048 x 2048 pixel > 7000 fps @ 2048 x 16 pixel
<b>dynamic range A/D<sup>5</sup></b>	16 bit
<b>pixel scan rate</b>	286.0 MHz
<b>binning horizontal</b>	x1, x2, x4
<b>binning vertical</b>	x1, x2, x4
<b>region of interest (ROI)</b>	horizontal: steps of 4 pixels vertical: steps of 1 pixel
<b>non-linearity</b>	< 1 %
<b>cooling method</b>	+ 7 °C stabilized, 1 stage peltier with forced air (fan)
<b>input signals</b>	optical trigger (FOL), electrical trigger, arm input (TTL level, BNC connectors), gate disable (high-speed TTL input, BNC connectors)
<b>output signals</b>	gate/expos out monitor, user monitor output (TTL level, BNC connectors)
<b>time stamp</b>	in image (1 µs resolution)

» exposure modes

**single image mode**

exposure times	4, 10 ns fixed, 20 ns ... 250 ns (1 ns steps), 250 ns ... 1 s (10 ns steps)
delay times	0 ns ... 250 ns (1 ns steps), 250 ns ... 1 s (10 ns steps)
maximum repetition... ...with external gating	200 kHz sustained, 3.3 MHz burst
insertion delay	
trigger input to exposure out	19 ns
trigger input to optical open	49 ns
jitter	
trigger input to exposure out	35 ps rms
trigger input to optical open	150 ps rms

**double image mode**

exposure times	20 ns ... 1 ms (in 10 ns steps)
delay settings	0 ns ... 10 ms (in 10 ns steps)
interframing time	300 ns ... 10 ms (in 10 ns steps)

<sup>5</sup> The high dynamic signal is simultaneously converted at high and low gain by two 11 bit A/D converters and the two 11 bit values are sophistically merged into one 16 bit value.

» general camera system

<b>power supply</b>	18 ... 28 VDC
<b>power consumption</b>	35 ... 40 W
<b>weight</b>	7 kg
<b>operating temperature</b>	+ 10 °C ... + 40 °C
<b>operating humidity range</b>	10 % ... 80 % (non-condensing)
<b>storage temperature range</b>	- 10 °C ... + 60 °C
<b>optical mount</b>	F-mount optional: C-mount, Canon EF mount
<b>vacuum mount (optional)</b>	sealed camera front attaches to vacuum equipment
<b>lens remote controller (optional)</b>	electronic control for Canon EF lenses
<b>maximum cable length</b>	10 km (CLHS FOL)
<b>CE / FCC certified</b>	yes

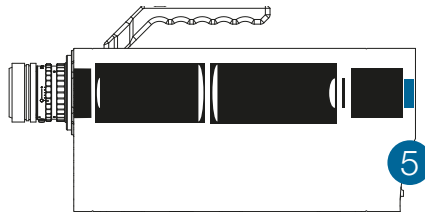

**technical specifications**

» camera interface

<b>data transfer</b>	Camera Link HS, FOL cable, frame grabber (Single F2, 1X1, S10)
<b>maximum cable length</b>	10 km (CLHS FOL)
<b>input signals</b>	optical trigger (FOL), electrical trigger, arm input (TTL level, BNC connectors), gate disable (high-speed TTL input, BNC connectors)
<b>output signals</b>	gate/expos out monitor, user monitor output (TTL level, BNC connectors)



**technical specifications**

» **lens remote controller**

The optional Canon lens control adapter enables you to connect electronic EF and EF-S Canon lenses allowing to remote control focus and aperture of these lenses.



» **dimensions**

F-mount and C-mount lens changeable adapter. All dimensions are given in millimeter.

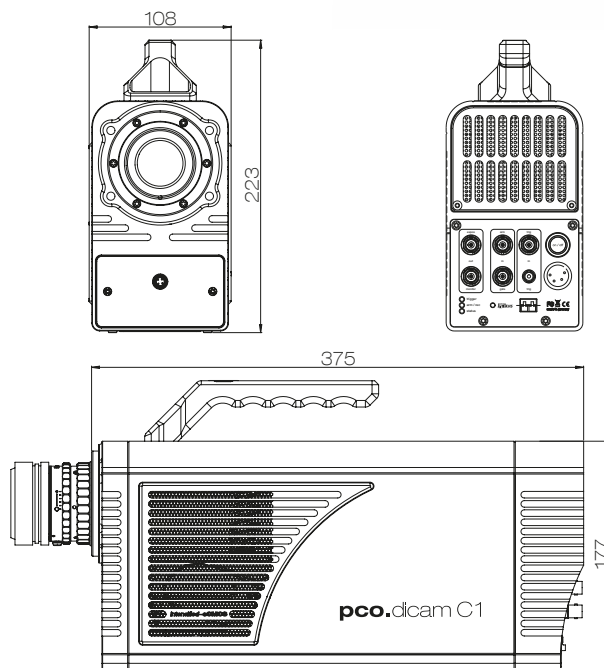

» **camera view**



» applications

laser induced incandescence (LII) | shock wave physics | laser induced breakdown spectroscopy (LIBS)  
particle image velocimetry (PIV) | time resolved spectroscopy | plasmaphysics | laser induced fluorescence (LIF)  
ballistics | combustion

» software

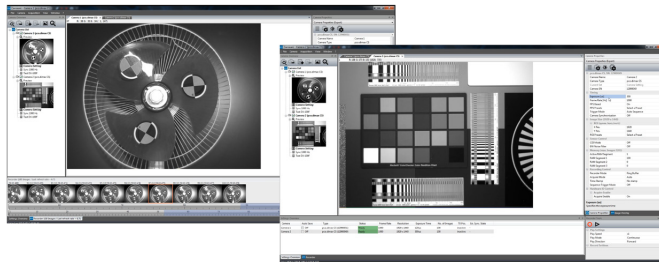

With pco.camware you control all camera settings, the image acquisition, and the storage of your image data. The pco.sdk is the complementary software development kit. It includes dynamic link libraries for user customization and integration on Windows PC platforms. Drivers for popular third party software packages are also available for you.

» third party integrations



**customization**

» possible combinations

photocathode	input window	phosphor
S20 selected	synthetic silica	P46
		P43
GaAs standard	borosilicate	P46
		P43
GaAs selected	borosilicate	P46
		P43
GaAsP standard	borosilicate	P46
		P43
GaAsP selected	borosilicate	P46
		P43

Image intensifiers with GaAs and GaAsP photocathode are available in two quality grades.

<b>standard</b>	quality specified for central 16 mm x 16 mm square region corresponding to 1300 x 1300 pixel sCMOS sensor resolution
<b>selected</b>	quality specified for 24.9 mm diameter area corresponding to full 2048 x 2048 pixel sCMOS sensor resolution, extinction ratio 10 times higher than standard grade, image intensifiers with S20 photocathode exclusively come in selected grade quality. Contact our technical sales team for further details on the two quality grades

» select optical mount

F-mount
C-mount
Canon EF mount

» select interface

type of fiber optic interface (CLHS FOL) module in camera and frame grabber

SM SFP+ up to 10 km
MM SFP+ up to 300 m
FOL cable length default: 10 m